



**DT-1001-LN**



**DT-1001-RS**

*Changing the Way the World Takes Temperature*

**User's Manual & Reference**

# Table of Contents

<b>The Instruments</b>	1	<b>Clinical Applications</b>	17
The Instruments Features	2	Regional Blocks	17
Contact vs Non-Contact Measurements	2	Epidural Catheter Positioning	17
Operation and Controls	2	Joint Inflammation	18
ON/OFF	3	Digital Perfusion Assessment	18
To Lock Reading	3	Reconstructive Surgery	19
To Restart	3	Lower Back Pain	19
Operating Modes	3	Diabetic Foot Screening	20
Non-Contact Scanning	4	Peripheral Nerve Injury	20
Changing the Battery	4	Cerebrovascular Disorders	21
Fahrenheit or Celsius Conversion	5	Neonatal Skin Temperature	21
Care and Maintenance	5	Wound Management	21
Self Diagnostics	6	Thermal Assessment of Skin Diseases and Allergy	22
Customer Service	6	Skin Temperature in Prognosis of the Critically Ill	22
<b>Body Surface Temperature</b>	7	Temperature Gradients in Detection of Shock	23
History and Introduction	7	Raynaud's Syndrome	23
Body Surface Temperature	8	Other Areas or Applications of Interest	24
Infrared Thermometry	9	<b>References</b>	25
The DermaTemp Infrared Thermographic Scanner	11	<b>Product Specifications</b>	27
Method Impedimenta	11	<b>Warranty Information</b>	28
Ambient Effect on Body Surface Temperature	12		
Solving the Problems	12		
Emissivity	13		
Alice's Quest for Emissivity	14		
Correcting for Emissivity Automatically	15		
Detection by Exception	15		

# The Instruments

The DermaTemp is a high precision hand-held infrared thermographic scanner designed to detect the subtle skin temperature variations caused by underlying perfusion variations.

These instruments feature a patented automatic emissivity compensation system for absolute accuracy regardless of skin type or color, and provide an instant temperature measurement on any surface location on the human body without the need for tissue contact.

In those applications where tissue contact is desirable or cross-contamination is an issue, the use of disposable sheaths allows even moist or wet tissue to be measured with precision accuracy.

## The models include:



### DT-1001-LN

The standard model



### DT-1001-RS

DT-1001 RS has a remote stainless steel sensor attached to the instrument by cable, convenient for those especially hard to reach areas.

All instruments can be cleaned with any hospital approved disinfectant, including bleach.

The DermaTemp is recommended for use in such areas as plastic and vascular surgery, anesthesiology, pain management, rheumatology, neurology, oncology, and wound management.

## **The Instruments Features**

- Full range resolution to 0.1°F/C
- SCAN, MAX and/or MIN modes of operation
- Fahrenheit/Celsius conversion
- A 10-second display lock
- An audible beeper to signal functional or conditional changes
- Hermetically sealed sensing system to withstand cleaning with any hospital approved disinfectant including bleach and alcohol.
- Pencil-like stainless steel sensor on the RS version.

## **Contact vs. Non-Contact Measurements**

In using any infrared temperature device, closer is always better, as the field of view increases proportionately to the distance from the surface. Accordingly, for maximum accuracy the probe must contact the surface at the point of interest. It does not need to be tightly pressed to the surface; a gentle touch is all that is required.

When contact with the surface is not an option, position the probe within 1/2 inch of the surface of interest. If using a non-contact protocol, the relative temperature indication of the instrument will be accurate.

## **Operation and Controls**

The DermaTemp 1001 infrared thermographic scanner models are all identical in performance and specifications. All are maximized for ease of use. The remote sensor on the RS version can either be left attached to the instrument for one-handed operation, or separated for use in hard-to-reach areas of interest. The LN model can be used with or without disposable sheaths. Disposable sheaths are primarily intended for temperature measurements that come in direct contact with the skin surface being measured for the highest possible accuracy. If the sheath does not touch the intended target the displayed temperature may be indicated as slightly lower than the actual temperature. The plastic sheath covering the sensor will slightly reduce the infrared energy of the target site. When the sheath is in contact with the skin surface being measured it will come to the same temperature as the target, thereby minimizing any temperature measurement error.

## **Using the DermaTemp**

The DermaTemp is equipped with an ON/OFF power button and a mode selector switch. The mode selector switch allows you to choose one of the three modes of operation: SCAN, MAX, or MIN.

## ON/OFF

To turn the instrument on, depress the red ON/OFF power push button. The single beep will audibly indicate that the instrument is on.

*The display will momentarily read 8888, an indication that the microprocessor is performing a self-diagnostic check. After the test, the unit will measure and display temperature in the selected operating mode for as long as the power button is depressed.*



## To Lock Reading

Release the red ON/OFF button to lock reading on display. The single beep will audibly indicate that the display is locked. The DermaTemp will hold the last reading on the display for 10 seconds before it automatically turns off.

## To Restart

Depress the button anytime to restart. It is not necessary to wait until the display is clear. The DermaTemp automatically recalibrates each time the button is depressed.

## Operating Modes

- **SCAN:** In the SCAN mode, the target's instantaneous temperature is continuously displayed and updated 10 times per second for as long as you keep the button depressed. After the power button is released, the display will lock on the last temperature measured and hold that reading for 10 seconds.
- **MAX:** In the MAX (peak hold) mode, the display will lock on the highest temperature measured for as long as you hold the power button down. Each time a new peak temperature is measured or repeated, an audible beep will sound. After you release the power button, the display will lock on the maximum recorded temperature and hold that reading for 10 seconds.
- **MIN:** In the MIN (valley hold) mode, the display will lock on the lowest temperature measured as long as the power button is depressed. Each time a new low temperature is measured, a beep will sound. After the power button is released, the display will lock on the minimum recorded temperature and hold that reading for 10 seconds.

## Non-Contact Scanning

For situations where even light contact is contraindicated, bring the instrument nose as close to the measuring site as safely possible, keeping the following in mind:

- The instrument's field-of-view, also referred to as the distance-to-spot ratio, is 1:1. A 1:1 field-of-view means that the sensor sees a circular area with a diameter equal to the distance between the sensor and the target area.
- For example, at a distance of 5 cm (2 inches), the sensor sees a 5 cm (2 inch) diameter spot. The minimum spot size is approximately 6 mm (1/4 inch) when touching.
- The DermaTemp averages the temperature of everything in its field-of-view.
- A small hot spot may get lost in a large viewing area. The closer you hold the instrument to a surface, the sharper its target resolution.

## Changing the Battery

The DermaTemp is powered by a standard 9-volt alkaline battery. To replace, loosen the four captive screws and remove the cover. Disconnect the old battery and replace with a new one in the same location. Replace the cover and tighten the four screws. Use only high quality alkaline batteries or their equivalent.

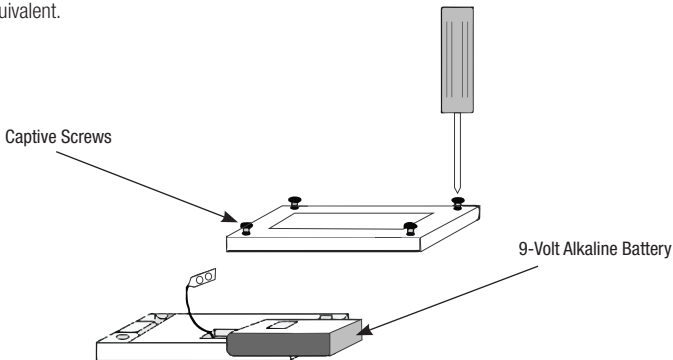

## Fahrenheit or Celsius Conversion

The DermaTemp can be used in either °F or °C. The only tool necessary to convert from one scale to the other is a paper clip.

- Find the small hole on the left side of the red display filter.
- Straighten the paper clip.
- Insert the end of the paper clip into the hole and push to activate the small switch underneath.
- While holding the paper clip pressed into the switch, turn the instrument on by pressing the red button.
- Remove the paper clip.
- To return to the original setting, repeat the process. The thermometer must be in the 'Off' condition to toggle F to C (or back) when converting the temperature scales.

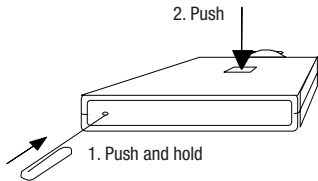

## Care and Maintenance

### Handling

Your DermaTemp is designed and built to industrial durability standards in order to provide long and trouble-free service. However, it is also a high precision optical instrument, and should be accorded the same degree of care in handling as you would provide other precision optical instruments, such as cameras or otoscopes.

### Calibration

Factory calibration data is installed via a computer through an optical link with the microprocessor. The instrument automatically self-calibrates each time it is turned on using this data, and will never require recalibration. If readings are not correct, the instrument should be returned for repair.

### Cleaning

The DermaTemp can be wiped down with any hospital approved disinfectant, even bleach. With normal use, the only maintenance required is to keep the lens on the end of the probe clean. It is made of special mirror-like, infrared transmitting material called Germanium.

Dirt, greasy films or moisture on the lens will interfere with the passage of infrared heat and affect the accuracy of the instrument. Regularly clean the lens with a cotton swab dampened with an alcohol wipe. Use only light force for cleaning to avoid damaging the lens. Water can be used to remove any residual film left by the alcohol. Use 70% isopropyl alcohol. Periodic cleaning is a good practice.

## Self Diagnostics

### Continuous Single Beeping

The high performance DermaTemp continuously monitors its ability to produce accurate temperature readings. If either the target's temperature or the unit's ambient temperature exceeds the operational limits, the beeper will sound once per second and the LED display will default to a display message.

When the target temperature is outside of the instrument's operating range, the unit will display either HI or LO and will beep continuously at one beep per second. When the instrument's own temperature is outside operating limits for ambient temperature, the display will show either HI A or LO A, and will beep continuously at one beep per second.

### Continuous Double Beeping

The battery voltage is also monitored. A low battery is indicated by a continuous double beep per second. Temperatures will continue to be displayed as long as accuracy can be assured. If the battery drops below 5.7 volts, it is considered "dead" and the display defaults to (----).

## Customer Service

### If repair is required:

- Contact Exergen for a Return Materials Authorization Number (RMA).
- Mark the RMA number on the outside of your package and packing slips.
- Include a description of the fault if possible.
- Send the instrument freight/postage prepaid to:  
Exergen Corporation  
400 Pleasant Street  
Watertown, MA 02472 Attention: RMA \_\_\_\_\_
- The instrument will be returned freight/postage prepaid.

### Questions:

Should you have any clinical or technical questions, please contact a customer service representative in the medical division at Exergen Corporation. They may be contacted either by phone (617-923-9900), fax (617-923-9911) or email to [medical@exergen.com](mailto:medical@exergen.com).



# Body Surface Temperature

## History and Introduction

As early as 2800 BC, the Egyptians, using the scanning sensitivity of the fingers over the surface of the body, recognized that the body produces heat, and that heat increases with disease. Further recognizing the distinction between local inflammation and fever, the Egyptians set the foundation for monitoring body surface temperature as a separate and distinct diagnostic methodology from the monitoring of core body temperature.

But the ancient diagnostic technique of feeling for heat is highly subjective, and only as sensitive as the hand of the feeler. The test of temperature is relative to the detector.

A cold hand will indicate a warm body surface that a warm hand will indicate as cold. Certainly, the hand of an experienced physician laid upon the skin could provide much useful information about the temperature of the patient and the course of an illness, but eventually a more objective assessment was possible with the introduction of the clinical thermometer developed during the last century.

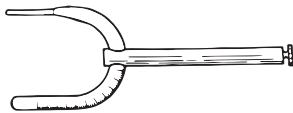

Typical 19th Century Thermometer

One of the earliest references to actually quantifying body surface temperature as a clinical diagnostic was in 1864 during the Civil War. Dr. Jackson Chambliss, a surgeon in the Confederate Army, used a thermometer to diagnose a traumatic femoral aneurysm by showing that surface temperature was decreased distally in the affected leg.<sup>1</sup>

In more recent times, the measurement of the surface temperature of the human body has not been routinely undertaken in many clinical environments not because the measurement lacks clinical significance, but because it has been difficult to acquire. Conventional mercury or electronic thermometers have generally been ineffective for surface temperature measurements for three reasons: 1) they are difficult to properly attach to the body surface, 2) they require a significant amount of time for the sensor portion of the device to equilibrate to the body surface temperature and 3) they are prone to low readings because it is not always evident that the surface thermal connection is adequate.

## Body Surface Temperature

Heat signatures vary considerably over the surface of the human body, and physicians have long appreciated the relationship between heat and disease. In fact as early as 400 BC, Hippocrates wrote “In whatever part of the body excess of heat or cold is felt, the disease is there to be discovered.”<sup>2</sup> Undoubtedly the earliest use of clinical thermography, Hippocrates found when he covered his patient’s body with wet clay, the mud dried quicker on the diseased area, thus presenting a crude but dramatic demonstration of the heat signatures.

It is impossible to define the surface temperature by any single normal value, since it is the result of a thermal balance between energy supplied from the core via perfusion and energy lost to the environment via radiation, conduction, convection, and evaporation. All objects, whether animate or inanimate, homeothermic or poikilothermic, radiate electromagnetic energy (radiation) to the surroundings at a rate dependent on its temperature. In accordance with a basic law of physics, this invisible radiation is constantly emitted, absorbed, and re-emitted by everything in our surroundings so that thermal equilibrium can be maintained. A simple example: left in normal room temperature, a cup of hot coffee quickly cools and a glass of iced tea quickly warms to the temperature of the room.

If the human eye had the optical power to see the emitted radiation, which has all the same properties as a beam of light, but differing in wavelength, all mankind would have an incandescent glow. Because the temperature over the surface of the human body changes at a rapid rate in response either to its external environment or to its internal control mechanism, the incandescence would be quite bright over some areas and quite dark over others. This variability of the temperature pattern gives question as to its significance, and yet it is a remarkable indication of the underlying body physiology.

All biological tissue generates energy in proportion to the metabolic activity occurring within the cells. About 80% of the energy developed by the human body is converted into heat, with the balance converted into external work or into tissue growth. The circulatory system, in addition to circulating blood for its metabolic characteristics also distributes heat, thus replacing the heat energy lost to the environment, as well as nourishing the tissue. The resultant increase in heat energy delivered by the blood causes the temperature to rise until the heat energy lost to the environment again balances with the heat delivered. It has long been recognized that where there is injury or infection, there is inflammation, but injury or

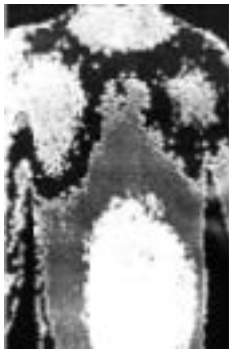

Thermographic scan of the patient with clay on his body. (Dorex, Inc. CA)

infection of itself does not create heat energy. When there is trauma, whether an injury or abnormal stimulation caused by a physical, chemical, or biologic agent, a pathologic process of reactions occurs in the blood vessels and adjacent tissues in response to the perturbation. The natural defense mechanism triggered immediately increases the flow of blood to the area of concern, causing the temperature to rise in proportion to the increase in blood flow. However, the maximum temperature can be no higher than that of the core arterial supply to the trauma tissue.

Consider as a simple analogy, the action of washing your hands in a sink. If the water from the hot faucet were to be trickling in a small stream, it is likely it would feel only lukewarm. However, if you were to open that tap full force, the rushing water would feel quite hot. But, no matter how intense the rush, the water could never be hotter than the water from its source of heat, the furnace.

The ancient diagnostic technique of feeling for heat over the body is a longtime indicator of inflammation. While localized temperature elevations may be felt merely by the touch of the hand, the technique is highly subjective, and not sufficiently sensitive to detect the subtle temperature rises indicative of increased cellular or metabolic activity. With the introduction of infrared techniques, accurate surface temperature patterns are immediately quantifiable and any changes easily detected. It is this knowledge that enables us to study any disease process resulting in a change in heat generation or thermal properties of the tissue.

## **Infrared Thermometry**

Temperature is a fundamental property of all matter related to its energy content, and can be described by a numeric value expressed on a scale of temperature. A human's touch produces an instinctive sense of hot or cold to judge the relative temperature of two objects. However, as a practical matter, clinicians must have a temperature scale that is independent of the observer, by which unknown temperatures can be evaluated. With a proper temperature scale, measurements taken at different times or places can be compared. Without a thermometer, it would be impossible to measure the temperature of a human with respect to a fixed scale of reference. Remember, the human test of temperature is relative to the detector. A cold hand will indicate a warm body surface that a warm hand will indicate as cold.

Numerous techniques and devices are employed in the measurement of temperature. Many of these techniques, such as the use of glass mercury thermometers or electronic display devices using thermocouples or thermistors, are generally understood and as a result well accepted in clinical medical practice. All three of the devices have one very important characteristic: they measure their own temperature, not the temperature of the object being measured, except in an indirect way. In

order to make an accurate temperature determination using one of these measurement techniques, it is necessary for the device to have intimate contact with the subject for sufficient time to raise the temperature of the thermometer to the same, or close to the same, temperature as that of the subject. Thermal contact thermometers require too much time to equilibrate, are sensitive to variations in contact pressure resulting in changes in the thermal resistance between the skin and the temperature detector, and tend to have too great a variation from reading to reading. If these devices are not properly located, properly attached, or left in place for enough time to equilibrate, they all will give incorrect readings.

The infrared method is fundamentally different from the other methods in that there is no temperature device to heat. Like an eye, the infrared instrument simply looks at the heat radiation naturally emitted from the body surface. Since there is nothing to heat, the measurement can be made very fast, orders of magnitude faster than the probe devices.

Historically, most of the published clinical data on body surface temperature measurements are based on the use of infrared thermography. Infrared thermography has long been recognized as a reliable, highly technical diagnostic tool, and refers to the process of recording and interpreting variations in temperature of the surface of the skin in color or shades of gray. The clinical information is contained in the relative temperature profiles. The technique is effective, but the equipment is complex and expensive.

Decades ago, the common image of a computer was that of an enormous, very expensive piece of equipment, something requiring an environmentally controlled room and complex installation. Today's computers have been reduced to hand held units. Infrared thermography was not a lot different: large and expensive, requiring environmentally controlled rooms, trained technicians, and exotic gases. Today's advanced technology makes it possible to put the power of infrared thermography in the palm of your hand, at a fraction of the cost of all previous techniques. While there are a variety of infrared thermometers available, only one is designed specifically to meet the stringent clinical requirements, the DermaTemp Infrared Thermographic Scanner.

## The DermaTemp Infrared Thermographic Scanner

The DermaTemp is a high precision handheld infrared thermographic scanner designed to detect the subtle skin temperature variations caused by underlying perfusion variations. These instruments instantly measure temperature on any surface location on the human body without the need for tissue contact. The DermaTemp is highly recommended for use in plastic and vascular surgery, anesthesiology, pain management, rheumatology, neurology, oncology, and wound management. Other applications follow this section.



DermaTemp 1001-LN and 1001-RS

Infrared thermometry is fast, stable, repeatable, and is relatively insensitive to user technique. Skin temperature measurements with infrared thermometry are attractive because they are objective, low cost, and cause absolutely no trauma or discomfort to the patient. The versatility of the products allows for absolute temperature measurement, surface scanning, and comparative methods of temperature differential.

### Method Impedimenta

Despite the tremendous benefits of using infrared technology for clinical applications, there are several impediments which should cause pause, such as variable skin characteristics, wet skin, and environmental influences. Since the process of measuring temperature by viewing the infrared radiation of the surface is significantly faster than the other techniques mentioned earlier, the user needs to be aware of several important considerations. The surface temperature of the human body is sensitive to the external environment and can vary by several degrees in a short period of time. Drafts will lower the surface temperature. A cold room environment will lower the surface temperature. Any surface moisture will lower the surface temperature. Exercise will raise the surface temperature due to increased perfusion as a thermoregulatory response. Exposure to the sun or any other warm surface will raise the surface temperature. The user needs to be aware of these concepts and not be surprised in the event the temperature readings are not as expected.

## Ambient Effect on Body Surface Temperature

The cardinal rule of interpretation of skin temperature is that the same environment will produce the same temperature if perfusion is the same. If the environment is the same and the temperature is different, then perfusion must be different. But body surface temperature can be significantly influenced by the temperature of the surrounding environment as evidenced in the table.

Effect of Ambient Temperature on Skin <sup>3</sup>		
Ambient	Hand	Forehead
4°C	8.9°C	13.7°C
23°C	26.9°C	29.2°C
27°C	33.2°C	33.2°C

Therefore, absolute temperature readings must be interpreted in relation to the environment, and the practitioner should be careful to protect the patient from drafts or exposure to large cold surfaces, to position the extremities to minimize pooling, and to allow time for the surface temperature to equilibrate to its environment.

The distribution of the temperature on the body surface is generally bilaterally symmetric. This symmetry can form the basis for clinical interpretation of the surface temperature data. The temperature data from the normal or reference area can also be used to adjust for the circadian variations and for variations in the temperature environment. In general, it is the relative readings between the body surface temperatures that are of interest.

## Solving the Problems

The DermaTemp is the result of many years of active scientific research in both the technology and clinical requirements. The patented reflective cup on the probe of the DermaTemp provides accuracy heretofore unavailable for clinical use. The instrument is completely unaffected by conditions prohibiting the use of other infrared devices. Because of its unique design, the classical problems in producing accurate temperatures have been solved.

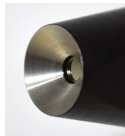

Reflective cup  
on probe tip

## Emissivity

An important concept needed to understand how temperature is measured using infrared radiation is the one of emissivity. Emissivity is a surface property which determines just how well an object's temperature can be measured by an infrared device. Emissivity (along with background thermal radiation) is the primary source of errors in infrared temperature measurement. Emissivity can be more easily understood if it is realized that infrared has similar properties to visible light.

Simply stated, emissivity is the opposite of reflectivity. A perfect mirror has a reflectivity of unity and an emissivity of zero. A perfect black body has an emissivity of unity and a reflectivity of zero. In actuality, all real bodies (including human ones) have an emissivity between these two limits.

**Poor Emitter**  
Emissivity = 0.1  
Reflectivity = 0.9  
**1.0**

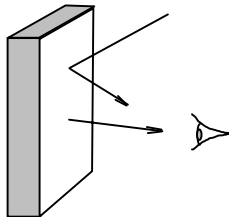

It is not possible to accurately measure the surface temperature of any body with an emissivity of less than 1.0 without making a correction for this source of error. Human skin is near but not equal to 1.0 and, if not accounted for, can introduce errors in the order of one to two degrees. The cup-like mirror used in the nosepiece of the DermaTemp scanner removes this source of error by trapping all of the radiation from the skin surface and in effect causing the skin surface to act like a black body with an emissivity of 1.0.

Mirrors figure prominently in the discussion of heat radiation and emissivity. Since heat and light radiation behave the same way, we can use what we see with our eyes as examples of what the DermaTemp sees. When you look in the mirror, you see only reflections, nothing of the mirror itself. If the mirror is perfect, it has 100% reflectivity. Because it reflects everything, it emits nothing. For this condition, the emissivity is zero.

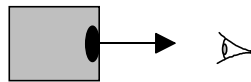

**Blackbody**  
Emissivity = 1.0  
Reflectivity = 0.0  
**1.0**

If we consider an imperfect mirror, the eye then sees mostly reflection, but also some of the imperfections on the mirror surface. If, for example, we saw 90% of the mirror as a perfect reflector and 10% as imperfections, 90% of the mirror would reflect; the remaining 10% would emit. Therefore, the emissivity equals 0.1.

Consider for a moment the exact opposite of a perfect mirror, which is a perfect emitter. The eye looks at a perfect emitter and sees no reflection at all, only the emitting surface. Since 100% of the surface emits, and 0% reflects, the emissivity equals 1.0. This type of object is called a blackbody.

And finally, consider a good emitter. The eye sees a small amount of reflection interspersed with the large amount emitting. If, for example, 10% of the surface did not emit, and instead reflected, then we would have 10% reflecting and the remaining 90% emitting.

Therefore, the emissivity equals 0.9. Accordingly, we can state the following rule of emissivity: ***The emissivity of the surface is simply the percentage of the surface that emits. The remaining percentage of the surface reflects.***

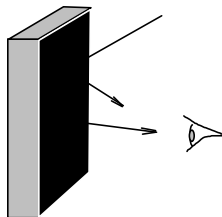

**Good Emitter**  
Emissivity = 0.9  
Reflectivity = 0.1  
**1.0**

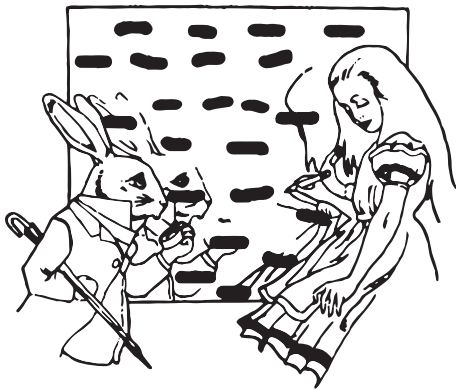

### Alice's Quest for Emissivity

#### Is it possible to see a mirror?

When the mirror is looked at, all other objects in the room are seen.

#### Is it invisible?

No, if it were, the wall would show behind it.

#### So how can it be seen?

If crayon spots are painted on the mirror, then the mirror can be seen. Of course, it can only be seen where there are spots. Everywhere else still reflects. Thus, light is emitted from the spots and reflected from the non-spots.

(Full reprint available from Exergen)



## Correcting for Emissivity Automatically

Biological tissue has high emissivity, i.e.  $\sim 0.95$ . Accordingly, the reflected component will be about 5% of the energy measured by the DermaTemp, which translates to an absolute error of  $\sim 1^\circ\text{F}$  ( $0.5^\circ\text{C}$ ). In addition, skin emissivity varies due to color, texture, etc. over the approximate range of 0.92 to 0.98. An uncertainty of approximately  $\pm 1^\circ\text{F}$  ( $0.5^\circ\text{C}$ ) results from this emissivity variation, which can appreciably influence the assessment of a subtle perfusion issue.

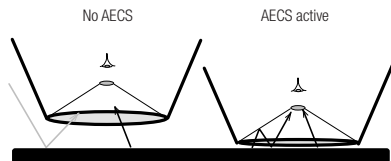

When AECS is active, ambient radiation is excluded and replaced by reflections of emitted radiation.

A more significant error is due to the reflected energy, which can vary considerably if the ambient radiation includes sunlight, radiant warmers, etc. To solve this problem the DermaTemp is equipped with a unique patented feature called Automatic Emissivity Compensation System (AECS). The reflective cup on the end of the probe automatically compensates for emissivity when it is touching, or brought to within approximately 1mm of the surface.

By excluding ambient radiation, and replacing it with reflections of emitted radiation, the emissivity is corrected, and the accurate temperature indicated.

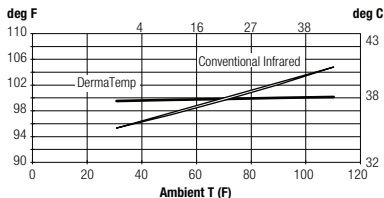

Effect of ambient temperature on infrared device readings for a surface at  $38^\circ\text{C}$  ( $100^\circ\text{F}$ ) with emissivity 0.9.

## Detection by Exception

The distribution of the temperature on the body surface varies appreciably. For example, on a normal individual, the highest average skin temperature is the forehead at  $34.5^\circ\text{C}$  ( $\pm 0.73^\circ\text{C}$ ) and the lowest average temperature is the toes at  $27.1^\circ\text{C}$  ( $\pm 2.72^\circ\text{C}$ ).<sup>3</sup> Considering the temperature of the skin is highly influenced by ambient temperature, one could wonder what diagnostic role, if any, temperature would play. The answer is that it plays a significant role, and the reason is the bilateral symmetry. Skin temperature differences from one side of the body compared to the other are not only extremely small, but also very stable, and unaffected by the age of the patient. Data show differences between sides at the forehead to be  $0.12^\circ\text{C}$  at the forehead, and  $0.25^\circ$  at the lumbar region of the back. This symmetry forms the foundation for clinical interpretation of the varying surface temperature data.

In general, it is the relative readings between the body surface temperatures that are of interest. Hence, the general principle is all detection is by exception. Accordingly, the temperature data from the normal or reference area can then be used to adjust for the circadian variations and for variations in the ambient temperature.

The change in body surface temperature with compromised blood flow is profound. A recent study was undertaken to mimic both partial and complete occlusion of blood flow to an extremity. The results indicate changes in skin surface temperature of an extremity reflect blood flow interruption or alteration in blood flow to that extremity.

A baseline for systolic blood pressure was determined for each subject and the manometer cuff inflated to three levels, 30 mmHg above systolic, 25 mmHg below systolic and 50 mmHg below systolic, with temperature readings taken on the inside wrist at 15 second intervals. Even at the lowest cuff pressure, there is a clear indication at the end of three minutes of the surface temperature change due to the lowered tissue perfusion caused by the reduction in arterial blood flow. The data also indicate the time between occlusion or partial occlusion and a measurable temperature drop is very short, well under one minute.

The surface temperature readings of the human body tend to be quite close between the bilaterally symmetric surfaces of region because of perfusion symmetry, but vary by several degrees on different body locations because of perfusion differences. Both the hands and the feet can be substantially colder than the rest of the body surface due to vasomotor constriction of arteriovenous shunts as a thermoregulatory response.

A striking example of perfusion effects can be demonstrated by compromise of circulation to the arm. A complete or partial occlusion of the artery in the upper arm will result in an immediate drop in hand temperature, and detectable in less than 30 seconds from the time of occlusion. The rapid response and the simplicity of infrared measurements make the technique effective in the hospital environment.

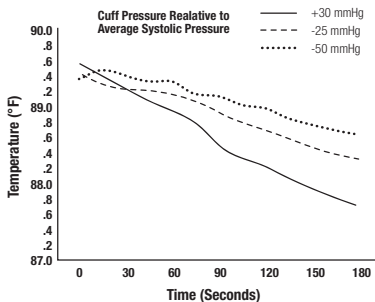

Effect of blood flow on body surface temperature

# Clinical Applications

The following is a brief synopsis of a number of clinical applications for surface temperature measurements. These subjects are not covered in sufficient detail to be used for clinical protocols and are intended to be general indications for the use of infrared temperature measurements for clinical purposes. Because of the sensitivity of surface temperatures to the environment, it is important that certain precautions be followed in making surface temperature measurements.

They are:

1. Provide for adequate equilibration time in the room environment at which the measurements will take place.
2. Protect the patient from drafts and exposure to cold surfaces (windows in winter).
3. Consider the use of a skin surface marker to ensure the measurement sites are repeatable.

## Regional Blocks

The effectiveness of regional blocks can be monitored using the change in surface temperature due to sympathetic vasodilation of the tissue in the blocked area, eliminating the subjective pin prick assessment method. Depending on the type and location of the block, one can expect to see a temperature increase in the order of 1 to 1.5°C on the skin surface of the blocked area in 10 to 30 minutes after the injection of the blockade drug.

In a recent study on sympathetic blockade, Chamberlain et al (1986)<sup>5</sup> measured the dynamic pattern of skin changes during spinal anesthesia, concluding skin temperature increase to be a useful indicator of sympathetic blockade, demonstrating that temperature elevation always preceded the upper limits of sensory blockade, and had a similar pattern of onset.

## Epidural Catheter Positioning in Labor and Delivery

Foot temperature has successfully been demonstrated as an indicator in the functional positioning of an epidural catheter. In a recent study conducted at Georgetown University Medical Center involving 70 parturients, Shin et al<sup>6</sup> confirmed the associated temperature changes provided better and objective evidence compared to the sensory pinprick test or subjective pain scales. The rapid and differential rise of foot temperature allowed early positioning of the patient with the unblocked cooler side down.

## Joint Inflammation

Thermographic techniques have generally been used to demonstrate that surface temperature variations are an effective means to assess joint inflammation due to trauma and disease. Although the technique is effective it is not readily available in most clinical situations. In almost any clinical environment, infrared thermometry can provide the same basic data rapidly and at low cost.

In a paper on skin temperature as an indicator of joint inflammation, Guadagni et al (1974)<sup>7</sup> describe the surface temperature elevation over arthritic joints and the correlation of this measurement with the more conventional inflammatory index. They concluded averaged joint skin temperature not only offers quantitative but as reliable and reproducible information about the degree of joint inflammation as conventionally used parameters such as inflammatory index, grip strength, and joint size. Recorded temperature data provides an objective means for the evaluation of the joint and its treatment modality over time. Both the magnitude of the temperature elevation and its profile across the joint may be used in the evaluation.

## Digital Perfusion Assessment

Levinsohn et al (1991)<sup>8</sup> demonstrated that the infrared method of assessing perfusion was as reliable as Doppler methods, but far less expensive, much faster, and easier to use.

A: Venous congestion was induced by placing a 28 mm wide cuff on the proximal phalanx of the long finger and then inflating the cuff to 5 mm Hg above resting diastolic pressure. With the aid of a nitrogen pressure regulator, cuff pressure was maintained for 60 minutes and assessment of digital perfusion was performed at 10 minute intervals using:

B: Laser Doppler Flowmetry

C: Pulse Oximetry

D: Skin Surface Fluorescence

E: Skin Surface Temperature Measurement via a DermaTemp (Levinsohn et al 1991).

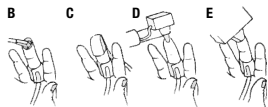
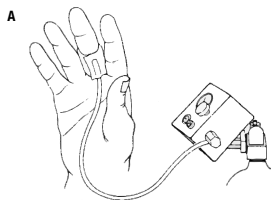

Evaluation of methods of detecting perfusion impairment

## Reconstructive Surgery

Despite satisfactory technical replantation, patients may develop vascular perfusion problems postoperatively, which lead to marginally perfused tissue or to failure. Because any significant change in perfusion is reflected as a change in body surface temperature, temperature measurement is an effective method of monitoring the ongoing viability of replants and flaps<sup>9</sup>.

Stirrat et al<sup>10</sup> (1978) study on the effect of temperature on digital replantation in perfusion may be recognized earlier via temperature monitoring and improvement gained by clinical measures before the need for reoperation occurs. The objective temperature measurements allow a nurse or nurses aide to follow condition, especially where skin color cannot be followed easily, e.g. dark-skinned patients or with severely traumatized or ecchymotic digits, calling the physician for significant changes. The technique is atraumatic, and avoids patient anxiety which produces unwanted peripheral vasoconstriction. Temperature monitoring is also inexpensive and readily available.

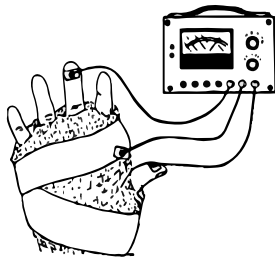

Stirrat et al (1978) study on the effect of temperature on digital replantation

Stirrat et al (1978) study on the effect of temperature on digital replantation in perfusion may be recognized earlier via temperature monitoring and improvement gained by clinical measures before the need for reoperation occurs. The objective temperature measurements allow a nurse or nurses aide to follow condition, especially where skin color cannot be followed easily, e.g. dark-skinned patients or with severely traumatized or ecchymotic digits, calling the physician for significant changes. The technique is atraumatic, and avoids patient anxiety which produces unwanted peripheral vasoconstriction. Temperature monitoring is also inexpensive and readily available.

## Lower Back Pain

Lower back pain is one of the most common complaints of patients seeing a physician. Many complaints originate from work related accidents and contribute to a tremendously large number of hours lost from work. A study of 800 patients presenting with lumbar complaints and radicular asymptotology by Weinstein et al<sup>11</sup> compared the relative value of five diagnostic modalities and confirmed the accuracy of temperature as a method of confirming the presence or absence of root syndrome in low back pathology to be well above the 90th percentile.

Barkan demonstrated that lumbar radiculopathy can be detected by temperature measurement with accuracy equal to CT Scan or myelogram.<sup>12</sup> These studies support the findings of many other similar studies,<sup>13, 14, 15, 16, 17</sup> and clearly support the use of temperature measurement as a non-invasive technique without radiation, capable of reducing the number of invasive and uncomfortable myelograms and expensive CT scans of the lumbar spine.

## Diabetic Foot Screening

Pedal infection is the most common cause of hospital admissions for diabetic patients in the United States and Great Britain<sup>18, 19, 20</sup>, with more than 50% of the 125,000 amputations performed in the United States each year directly attributable to their disease.<sup>21</sup> The American Diabetes Association estimates the costs of treating lower extremity amputations approaches \$10 billion annually, but interestingly, data from the Centers for Disease Control demonstrate up to 85% of diabetic foot and leg amputations can be prevented.

Temperature is an early indicator of foot problems in diabetic patients<sup>22</sup>. Long before any clinical manifestations, heat can be detected, and the more sensitive the detection instrument, the earlier the warning. As a key indicator of complications from the disease, temperature has been incorporated into routine diabetic foot screening protocols.<sup>23</sup>

Two foot problems of major concern are foot ulcers and neuropathic fractures. Because of peripheral neuropathy, diabetic patients may not feel pain, and can continue walking on the foot. If the problem is not identified and treated in a timely fashion, they are at high risk for ulceration, infection, and deformities, with amputation of a lower limb always a real and devastating complication.

Using the DermaTemp for temperature monitoring in diabetic foot screening can immediately determine the thermal geography of the area of concern, identify hot spots, and locate cool areas. As a diagnostic tool, it is objective and quantifiable. Because it is relatively insensitive to user technique, many physicians have recommended their patients monitor their own foot and leg temperatures with the DermaTemp as part of their patient's self-care program.

## Peripheral Nerve Injury

Temperature monitoring can be used in the quantification of peripheral nerve injury, differentiating among organic nerve damage, psychogenic factors, or even malingering.<sup>24</sup> Skin temperature is altered in the field of an impaired peripheral nerve due to sympathetic vasomotor disturbance. Skin temperature in a normal individual differs between sides of the body only  $0.24 \pm 0.073^{\circ}\text{C}$ . In patients with peripheral nerve injury, the temperature of the skin innervated by the damaged nerve deviates an average of  $1.55^{\circ}\text{C}$ .<sup>25, 26, 27</sup>

Temperature monitoring has been found to be highly successful in identifying the difficult pain problems e.g., diabetic or ischemic radiculopathy, facial pain syndrome, carpal tunnel, whiplash injuries of neck and upper back, and the phantom limb pain seen in amputees.

## **Cerebrovascular Disorders**

Temperature monitoring is a useful method for screening for cerebrovascular disease before subjecting the patient to the risk of invasive procedures. In the evaluation of extracranial carotid complex, temperature monitoring demonstrates a high degree of sensitivity in detection of hemodynamically significant stenosis of the internal carotid artery.<sup>28, 29</sup> Early detection allows the physician to institute appropriate therapy before a stroke occurs.<sup>30</sup>

## **Neonatal Skin Temperature**

The goal of neonatal thermal management is to establish an environment of thermoneutrality in which the metabolic heat production requirement is minimal. Perlstein<sup>31</sup> indicates that both the core and surface temperature of the neonate are required to quantify the rate of heat loss. The greater the difference between core and surface temperatures, the greater the heat loss from the infant. (This holds only if vasomotor activity is absent, as is the case for a neonate.) A typical surface temperature for minimum heat loss is indicated as 36.0-36.5°C (96.8-97.7°F).

Conventional thermal sensor systems are sensitive to the thermal contact resistance between the surface of the patient and the surface mounted device. A large thermal resistance will result in inaccurate surface temperature readings, tending to be on the low side of the actual surface temperature. This technique requires time for the sensor to equilibrate and great care in the surface mounting methodology for accurate measurements. As a consequence, conventional surface detectors are usually used to monitor one location on the neonate and multiple site readings are rarely taken.

Infrared thermometry provides a method for accurate surface temperature measurements on multiple skin surface locations. The infrared technology has a short one-second time interval between readings, is essentially independent of user technique, and has no variable thermal contact resistance problem. The capability of rapid and accurate multi-surface temperature measurements provides the clinician a new and expanded method for the assessment of heat loss from the body surface of the neonate.

## **Wound Management**

Increased skin temperature has long been associated with infection, thus measuring the changes in skin temperature in the area of incision or trauma when compared to the surrounding tissue provide the necessary quantifiable information for early recognition of such infections, well before the process has caused any visible skin changes.

Temperature measurement is especially useful for early diagnosis of postoperative wound infections.<sup>32</sup> Those at the IV site, and decubitus ulcers, for example, provide for routine quantification of the infection and subsequent monitoring of the healing process in an objective manner by the clinical staff.

### Thermal Assessment of Skin Diseases and Allergy

Temperature monitoring provides an objective assessment of skin diseases<sup>33</sup> as well as allergy and vasomotor tests<sup>34</sup> since most of the skin diseases, or the percutaneous injection of pharmacodynamic substances used for testing, generate significant changes in the thermal pattern of the skin.

### Skin Temperature in Prognosis of the Critically Ill

Skin temperature has been the subject of several studies monitoring blood flow in the critically ill. Data from these studies indicate increases in the temperature of skin, especially the big toe, were accompanied by improvement in the clinical status of the patient, and significantly greater survival. Boycks and Weil<sup>35</sup> concluded toe temperature provided the best correlation with cardiac index and prognosis of survival compared to arm, finger, thigh, or rectal temperatures.

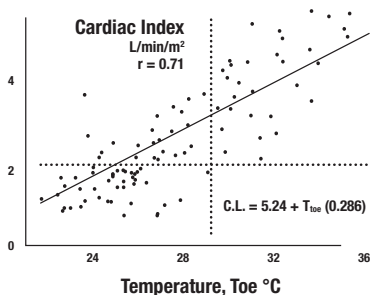

Toe temperature vs. cardiac index (Boycks et al)

Kholoussy et al (1980)<sup>36</sup> demonstrated attainment of normal rectal-toe temperature gradient consistently coincided with hemodynamic stabilization of the patient as indicated by other simultaneously measured parameters and by the clinical condition. In all the patients that died, rectal-toe temperature gradient gradually and progressively increased as the patient's condition became terminal.

Monitoring central peripheral temperature gradient was determined to accurately reflect the state of peripheral circulation, though may be limited by peripheral vascular disease, central hypothermia, and the use of vasoactive drugs.



## Temperature Gradients in Detection of Shock

Temperature monitoring of the gradient between forehead and sole temperatures has been demonstrated to provide early detection of masked symptoms during and after surgery. The effect of treatment and the prognosis for the patient are predictable according to the trends of the two temperatures as divergent or convergent. The dissociation when the two temperatures are more than 7°C apart from each other suggests that the hemodynamical condition is worse than in the convergence when they remain within 2°C.<sup>37</sup>

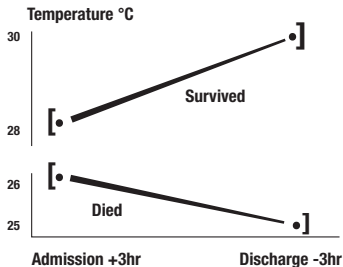

Toe temperature as a prognosis (Boycks et al)

The blood flow in finger skin is known to be very susceptible to sympathetic nervous activity. Palm tissue temperature varies more with the emotional stress than does sole tissue temperature. Assuming forehead and abdominal readings correspond to core temperature,<sup>38</sup> and sole and palm readings to shell temperature, the hemodynamical condition in convergence is usually better than in dissociation. If dissociation is observed in a post-op patient, the hemodynamical parameters have to be checked. When the arterial systolic pressure is less than 90 mmHg and the urine output less than 1ml/min/mg, a state of shock can be diagnosed based on the dissociation (difference >7°C).

A chilling sensation or shivering is common in dissociation, however, the symptoms can be overlooked in the patient just after surgery because an intubated patient cannot complain of a chilling sensation, and shivering does not occur in patients whose muscles are flaccid owing to residual pharmacological effects of anesthesia. Monitoring of the patient's body surface temperature allows for early detection of shock in postoperative patients with minimum discomfort and maximum safety to the patient.

## Raynaud's Syndrome

Temperature monitoring of patients with Raynaud's Syndrome provides a useful, non-invasive method of quantifying temperature and heat patterns in determining the underlying pathogenesis of Raynaud's attacks, and in the evaluation of any subsequent therapy. Temperature monitoring may also be useful diagnostic tool in differentiating primary from secondary Raynaud's. Preliminary research data suggest Raynaud's may be a common denominator in certain sleep disorders. Many patients with connective tissue diseases present with Raynaud's phenomenon, particularly those with scleroderma and progressive systemic sclerosis where it is the first symptom in 90% of cases, and may precede other manifestations by many years.<sup>39, 40</sup>

## **Other Areas or Applications of Interest**

- Bone Fractures
- Diabetic Neuropathy
- Oncology
- Stress Fractures
- Breast Cancer Screening
- Diseases of Scrotum and/ or Testicles
- Orthopedic Surgery
- Trigger Points
- Burn Injury
- Hansen's Disease
- Pagets Disease
- Tumor Screening
- Carpal Tunnel Syndrome
- Headache Clinic
- Pain Management
- Varicocele Detection
- Cerebral Vascular Disease
- Joint Trauma
- Peripheral Nerve Injury
- Vascular Obstruction
- Nerve Root Compression
- Soft Tissue Injuries
- Dentistry
- Neuromuscular Injury
- Sports Medicine

# References

1. Chambliss J. Case of traumatic femoral aneurism (sic) treated by digital compression/ligation afterwards of the external iliac artery. *Confederate States Med Surg J*, 1:97-99, 1864.
2. Coar T. The Aphorisms of Hippocrates with a Translation into Latin and English 88 (AJ Valpy, London 1822).
3. Robertson T. *Clinical Temperature Measurement - Survey*. CEC/Bell & Howell.
4. Uematsu S, Thermographic imaging of cutaneous sensory segment in patients with peripheral nerve injury. *J Neurosurg*, Vol 62, 717-720, May 1985.
5. Chamberlain DP, Chamberlain BDL. Changes in the skin temperature of the trunk and their relationship to sympathetic blockade during spinal anesthesia *Anesthesiology* 65:139-143, 1986.
6. Shin Y, Pearson L, Burnett M. *Anesthesiology* V77, No 3A, Sep 1992.
7. Guadagni DN, Dreith F, Smyth CJ, Bartholomew BA. Skin temperature as an indicator of joint inflammation, *ISA BM* 74321 (105-110), 1974.
8. Levinsohn G, Gordon L, Sessler DI: Comparison of four objective methods of monitoring digital venous congestion; *J Hand Surgery*, Vol 16, No 6, 1056-1062, Nov 1991.
9. Bloomenstern RB, Viability prediction in pedicle flaps by infrared thermography: *Plast. Reconstr. Surg.* 421:452-461, 1968.
10. Stirrat CR, Seaber AV, Urbaniak JR, Bright DS. Temperature monitoring in digital replantation. *J of Hand Surg, Am Soc Surg of the Hand*, 1978.
11. Weinstein SA, Weinstein G. Thermography, EMG, CT Scan, Myelography and Surgery in 800 Patients: Georgetown University Medical Center, 14th Ann Meeting, Am Acad of Thermology.
12. Barkan I, Thermography: A useful adjunct to differential diagnosis: lumbar radiculopathy versus plexopathy in 10 cases. Georgetown University Medical Center, 14th Ann Meeting, Am Acad of Thermology
13. Albert SM, Glickman M, Kallish M: Thermography in orthopedics, *Ann NY Academy of Science* 121, 157-170, 1964.
14. Heinz ER, Goldberg HI, Taveras JM: Experiences with thermography in neurologic patients. *Annual NY academy of Science* 121:177-189, 1964.
15. Raskin M, Martinez-Lopez M, Sheldon JJ: Lumbar thermography in discogenic disease. *Radiology*:119:149-152, 1976.
16. Tischauer IR: The objective corroboration of back pain through thermography. *J Occup Med*:19:727-731, 1977.
17. Ching C, Wexler CE: Peripheral thermographic manifestations of lumbar disc disease. *Appl Rad*:100:53-58, 1978.
18. Levin ME: Pathophysiology of diabetic foot lesions. In Davidson JK (ed): *Clinical Diabetes Mellitus: A Problem-Oriented Approach*, p504. Thieme Medical, NY, 1991.
19. Gibbons G, Eliopoulos GM. Infection of the diabetic foot. In: Kozak GP, Hoar CS, Rowbotham JL, (eds). *Management of Diabetic Foot problems*. 97-102, WB Saunders, 1984.
20. Pliskin MA, Todd WF, Edelson GW. Presentations of Diabetic Feet. *Arch Fam Med*, 3:273-279, 1994.
21. Most RS, Sinnock P. The epidemiology of lower extremity amputations in diabetic individuals. *Diabetes Care*, 6:87-91, 1983.
22. Bergtholdt HT. Thermography on insensitive limbs: *Medical Thermography, Theory and Clinical Applications* 69-79, ed Uematsu S, Brentwood Publishing Co., Los Angeles, 1976.
23. Dorgan MB, Birke JA, Moretto JA, Patout CA, Rehm BD: Performing foot screening for diabetic patients. *AJN* 32-37, Nov 1995.

24. Uematsu S: Thermographic imaging of cutaneous sensory segment in patients with peripheral nerve injury. *J Neurosurg* 62:716-720, 1985.
25. Rasmussen TB, Freedman H: Treatment of causalgia: analysis of 100 cases. *J Neurosurg* 3:165-173, 1946.
26. Uematsu S, Shendler N, Hungerford D, et al: Thermography and electromyography in the differential diagnosis of chronic pain syndromes and reflex sympathetic dystrophy.
27. Wexler CE, Small RB: Thermographic demonstration of a sensory nerve deficit. *J Neurol Orthoped Surg* 3:73-75, 1981.
28. Ackerman RH, Noninvasive diagnosis of carotid disease in the era of digital subtraction angiography; *Neurol. Clin:*1;70-85, 1983.
29. Abernathy M, Nichols R, Robinson C, Brandt M. Noninvasive testing for carotid stenosis: Thermography's place in the diagnostic profile. *Thermology*;1;61-66, 1985.
30. Abernathy M, Chang L, et al. Cerebrovascular thermography: technique and quality control. *Am Acad of Thermology Ann Mtg. Georgetown University Medical Center*, 1985.
31. Perlstein P: Future directions for device design and infant management. *Medical Instrumentation* 21:1;36-41;Feb, 1987.
32. Robicsck F, et al. The value of thermography in the early diagnosis of postoperative sternal wound infections. *Thorac. Cardiovasc. Surg.* 32, 260-65, 1984.
33. Warshaw TG, Lopez F: Thermoregulatory function in skin: an aspect of psoriasis. *Acta Thermographica* 5:22, 1980.
34. Stuttgart G: Thermographic evaluation of the benign diseases and reactive changes of the skin: *Biomedical Thermology*, ed Gautherie M, Albert E. 397-411, Alan R Liss, Inc., NY, 1982.
35. Boycks E, Weil MH. Toe temperature as an indication of blood flow in the critically ill. *Biology and Medicine*, Ch 190, 2073-2078.
36. Kholoussy AM, Sufian S, Pavlides C, Matsumoto T: Central peripheral temperature: its value and limitations in the management of critically ill surgical patients. *Am J of Surgery*, Vol 140:609-612, Nov, 1980.
37. Tsuji T: Patient monitoring during and after open heart surgery by an improved deep body thermometer. *Medical Progress Through Technology* 12, 25-38, Martinus Nijhoff Publishers, Boston, 1987.
38. Benzing TH. Heat regulation; Homeostasis of central temperature in man. *Physiol Rev* 49:671-759, 1969.
39. Basset LW, Gold RH, Clements PJ, Furst D. Hand thermography in normal subjects and scleroderma. *Acta Thermographica*:5:19-22, 1980.
40. Haberman JD, Ehrlich GE, Levenson C: Thermography in rheumatic diseases. *Arch. Phys. Med and Rehab* 49:187-191, 1968.

# Product Specifications

<b>Clinical Accuracy</b>	0.1°C or $\pm 0.2^{\circ}\text{F}$
<b>Temperature Range</b>	18 to 43°C (65 to 110°F)
<b>Operating Environment</b>	16 to 43°C (60 to 110°F)
<b>Resolution</b>	0.1°C or °F
<b>Response Time</b>	Approximately 0.1 second
<b>Emissivity Compensation</b>	Automatic
<b>Time Displayed on Screen</b>	10 Seconds
<b>Battery Life</b>	Approximately 5,000 readings
<b>Case Dimensions</b>	9 cm x 18 cm x 2 cm (3.5" x 7" x 0.75")
<b>Weight</b>	255 gm (9 oz)
<b>Case Shielding</b>	Complete copper coating for EMI and RFI protection
<b>Display Type and Size</b>	Large, bright red LED's, easily readable in any lighting
<b>Construction</b>	Industrial duty, impact resistant casing, hermetically sealed sensing system
<b>NIST</b>	Certifiable traceable calibrations
<b>ASTM</b>	Meets or exceeds standards for electronic and radiation thermometers.

## **Five Year Warranty**

Exergen Corporation warrants each new Exergen DermaTemp (except battery) against defects in materials or workmanship for a period of five years from the date of purchase, and agrees to repair or replace any defective product without charge.

**IMPORTANT:** This warranty does not cover damage resulting from accident, misuse or abuse, lack of reasonable care, the affixing of any attachment not provided with the product or loss of parts or subjecting the product to any but the specified battery. Use of unauthorized replacement parts will void this warranty. Exergen Corporation will not pay for warranty service performed by a non-authorized repair service and will not reimburse the customer for damage resulting from warranty service performed by a non-authorized repair service. No responsibility is assumed for any special, incidental or consequential damages.

In order to obtain warranty service, simply call Exergen Corporation Customer Service, 617-923-9900, for an Return Material Authorization number (RMA). Then send the product, postage or shipping prepaid, to Exergen in accordance with the instructions given with the RMA number. It is suggested that for your protection, you ship the product, insurance prepaid. Damage occurring during shipment is not covered by this warranty.

**NOTE:** No other warranty, written or verbal, is authorized by Exergen Corporation. This warranty gives you specific legal rights and you may also have other rights which vary from state to state. Some states do not allow the exclusion or limitation of incidental or consequential damages, so the above exclusion and limitations may not apply to you.



**DT-1001-LN**



**DT-1001-RS**

# DermaTemp 1001 Series

*Changing the Way the World Takes Temperature*

**EXERGEN**  
CORPORATION

**Exergen Corporation**

400 Pleasant Street  
Watertown, MA 02472 U.S.A.  
617-923-9900  
[www.exergen.com](http://www.exergen.com)

P/N: 818511 Rev 5